

This drawing is the property of Country Lane Woodworking, LLC, provided by Timber Tech Engineering, Inc. and reproduction, alteration or use of this drawing without the written consent of Country Lane Woodworking, LLC is prohibited. Drawings shall not be scaled to obtain dimensions. The contractors and builders involved on this project shall verify all dimensions and conditions before starting work and any discrepancy shall be reported to the engineer in writing before starting work.

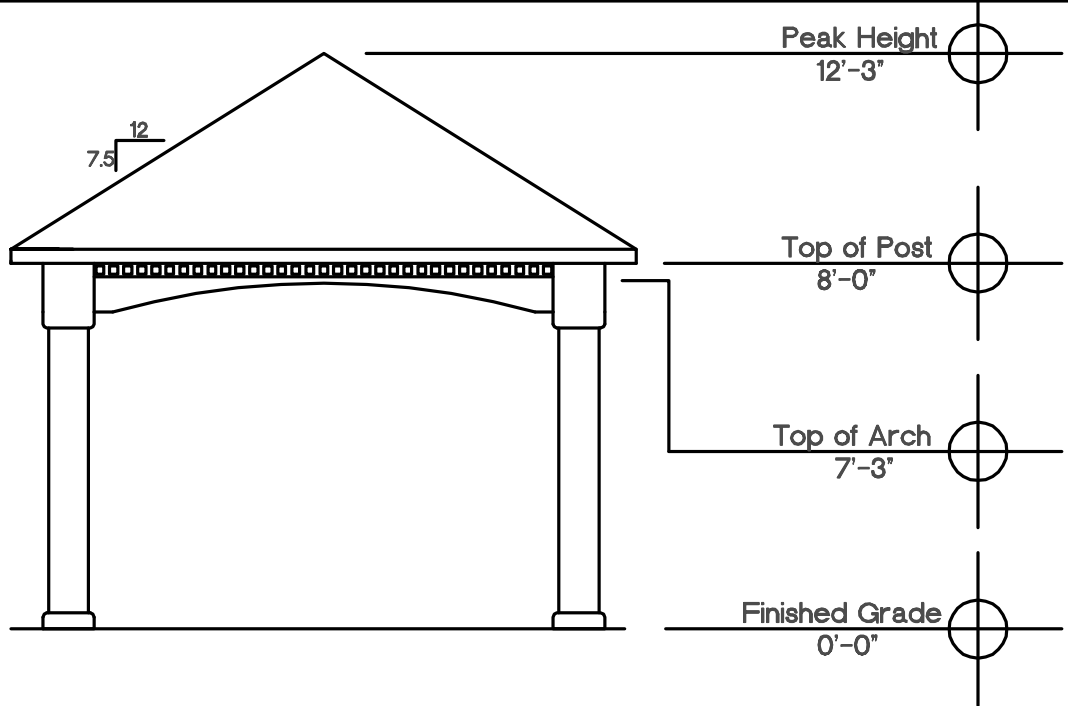

End Elevation 12'x14'

Scale $\frac{1}{4}" = 1'-0"$

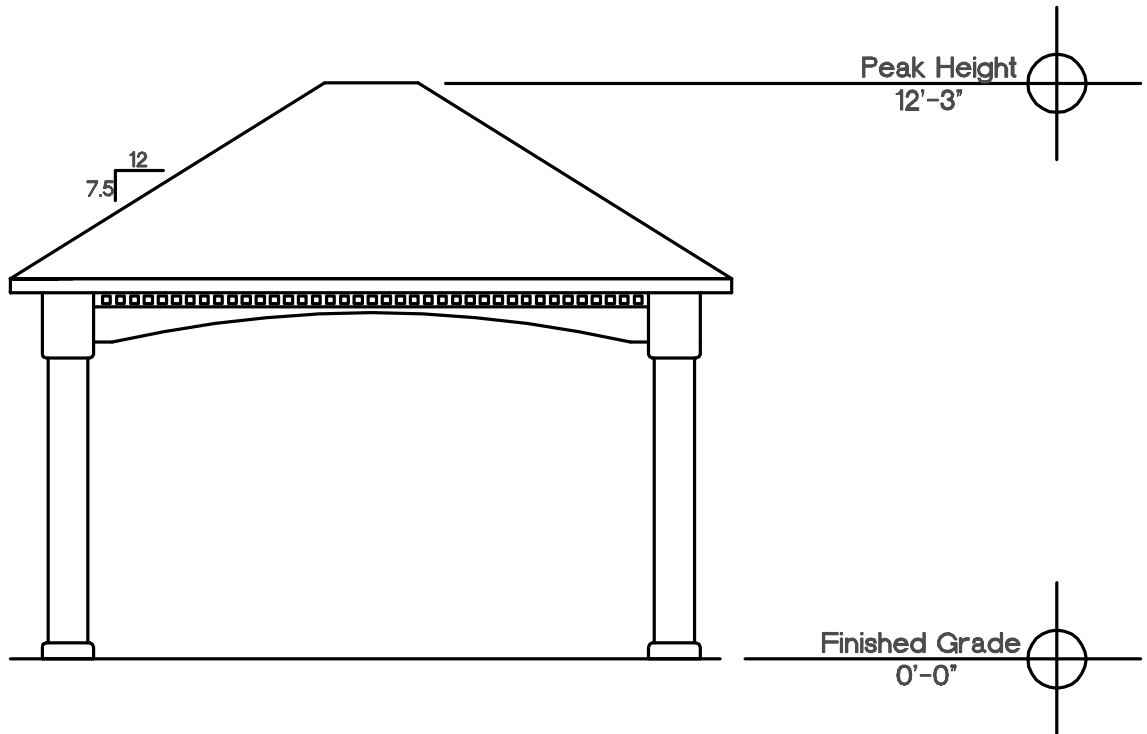

Side Elevation 12'x14'

Scale $\frac{1}{4}" = 1'-0"$

This drawing is the property of Country Lane Woodworking, LLC, provided by Timber Tech Engineering, Inc. and reproduction, alteration or use of this drawing without the written consent of Country Lane Woodworking, LLC is prohibited. Drawings shall not be scaled to obtain dimensions. The contractors and builders involved on this project shall verify all dimensions and conditions before starting work and any discrepancy shall be reported to the engineer in writing before starting work.

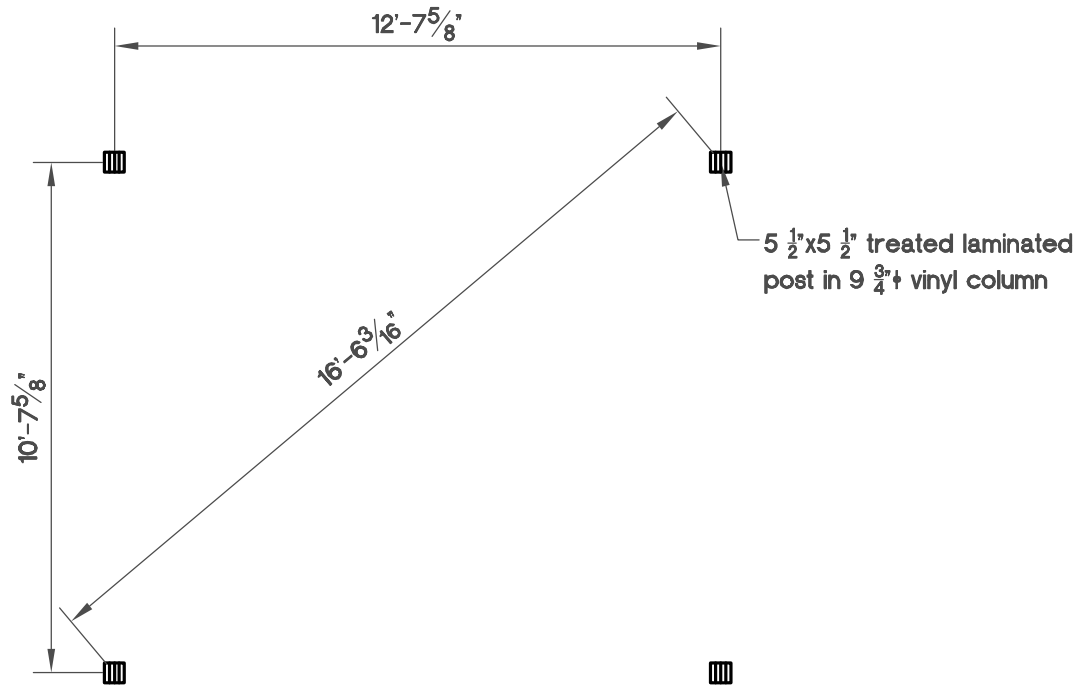

Post Layout Plan

Scale 1/4" = 1'-0"

Foundation Note:

The foundation for this pavilion is to be designed according to local code requirements using the design reactions from the chart on the cover sheet of the drawings by Timber Tech Engineering, Inc. having the same job number referenced above. The general pier and slab foundation concepts shown on page 4 and 5 have been designed as per the IBC 2009 using an allowable soil bearing pressure of 2000 psf. The turn down slab concept should only be used in locations with a design frost depth equal to or less than the depth of the thickened edge. This is not a site specific design, consult your local building department for specific foundation design criteria for your area before using these details

This drawing is the property of Country Lane Woodworking, LLC, provided by Timber Tech Engineering, Inc. and reproduction, alteration or use of this drawing without the written consent of Country Lane Woodworking, LLC is prohibited. Drawings shall not be scaled to obtain dimensions. The contractors and builders involved on this project shall verify all dimensions and conditions before starting work and any discrepancy shall be reported to the engineer in writing before starting work.

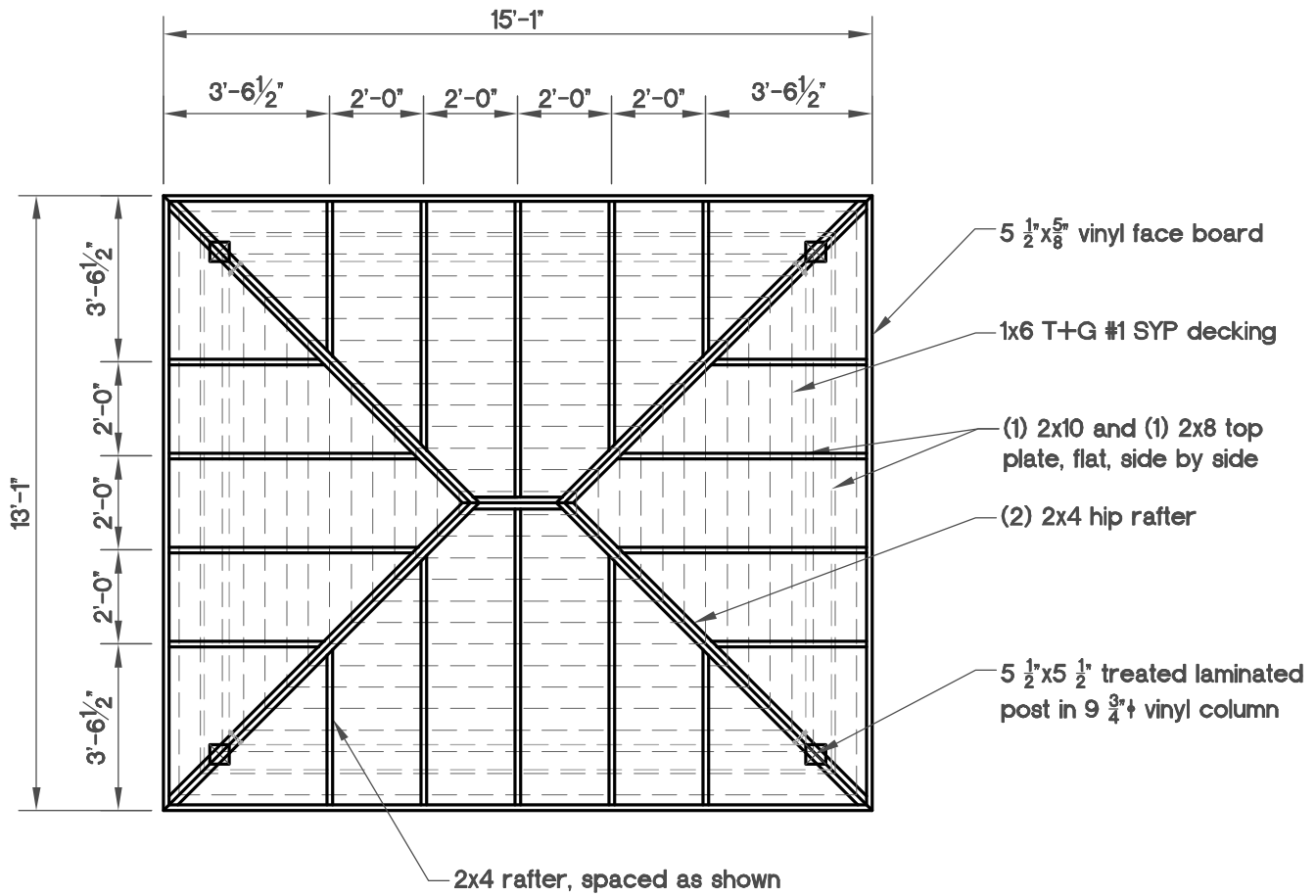

Roof Framing Plan

Scale 1/4" = 1'-0"

This drawing is the property of Country Lane Woodworking, LLC, provided by Timber Tech Engineering, Inc. and reproduction, alteration or use of this drawing without the written consent of Country Lane Woodworking, LLC is prohibited. Drawings shall not be scaled to obtain dimensions. The contractors and builders involved on this project shall verify all dimensions before starting work and any discrepancy shall be reported to the engineer in writing before starting work.

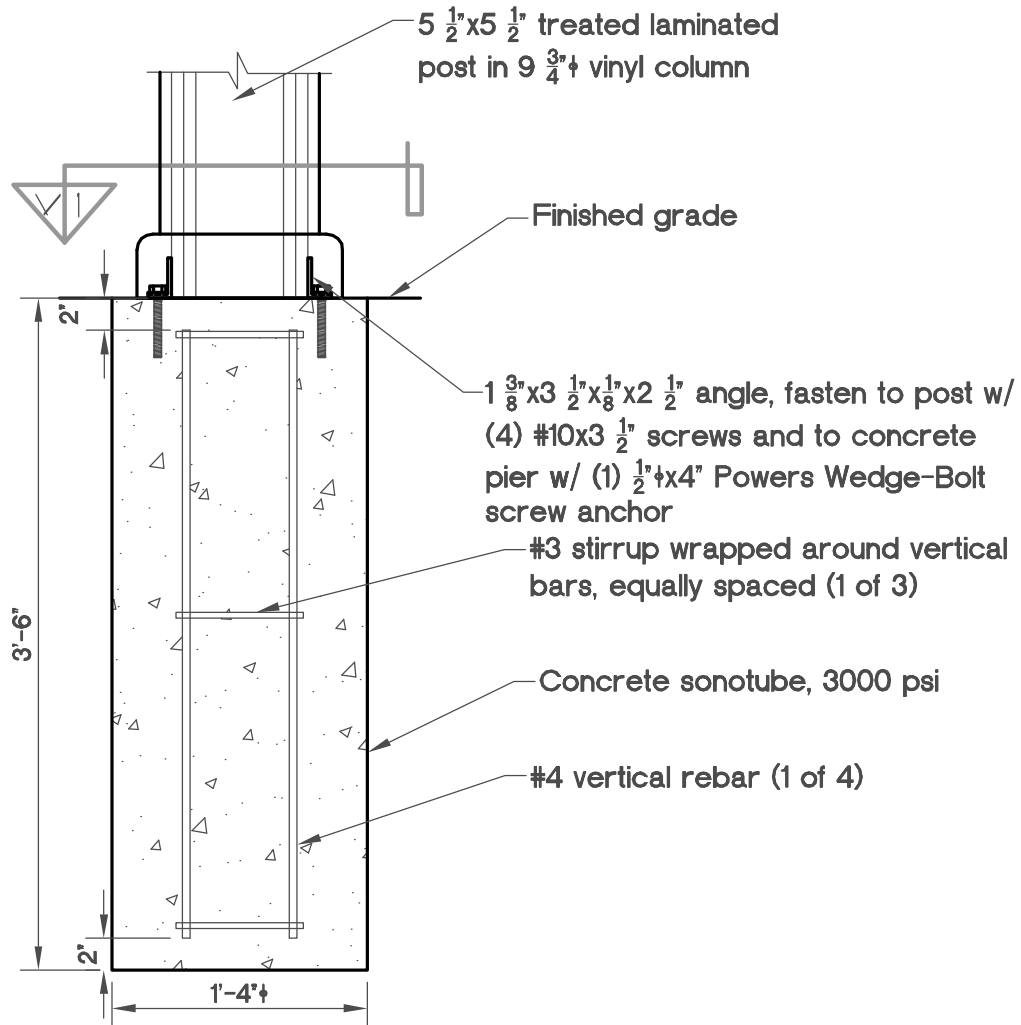

Pier Concept

Scale 1" = 1'-0"

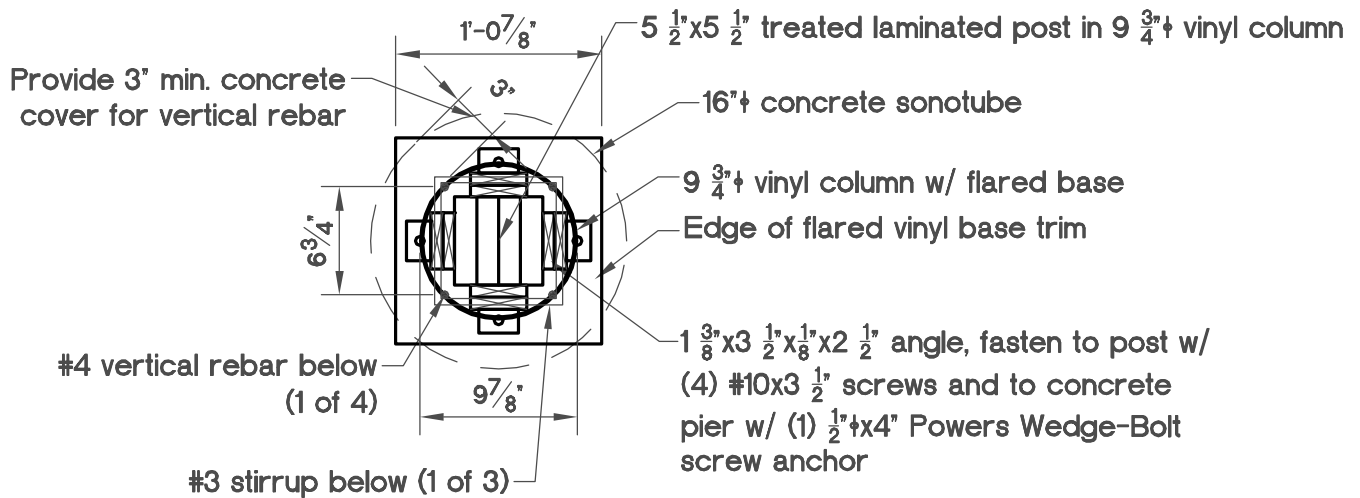

View 1 Pier Concept

Scale 1" = 1'-0"

See foundation note on page 2 for design information

This drawing is the property of Country Lane Woodworking, LLC, provided by Timber Tech Engineering, Inc. and reproduction, alteration or use of this drawing without the written consent of Country Lane Woodworking, LLC is prohibited. Drawings shall not be scaled to obtain dimensions. The contractors and builders involved on this project shall verify all dimensions and conditions before starting work and any discrepancy shall be reported to the engineer in writing before starting work.

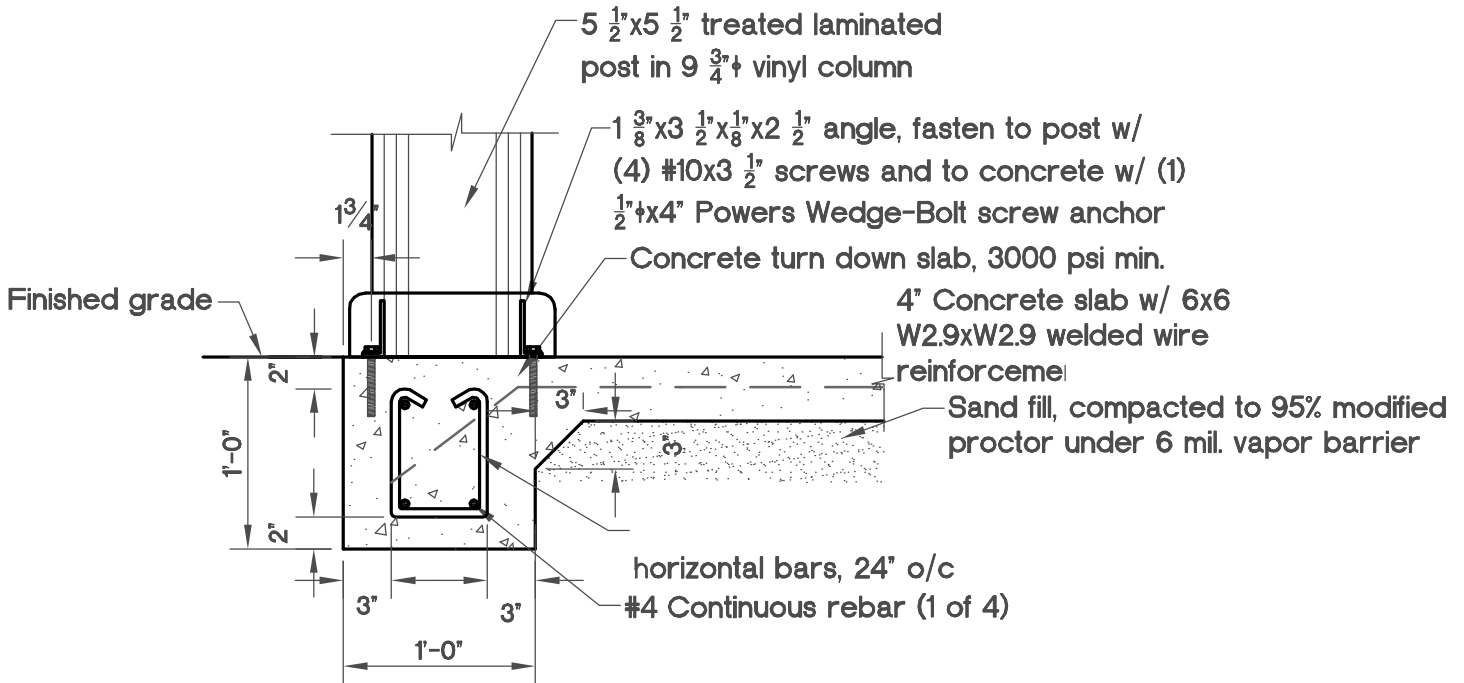

Slab Concept Scale 1" = 1'-0"

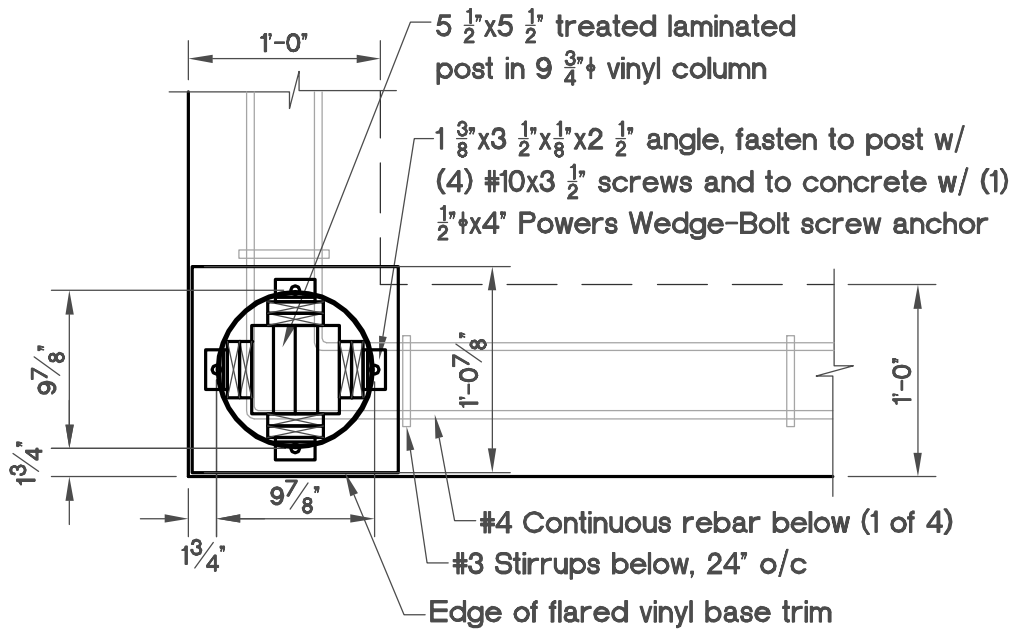

Corner Post Top View Concept Scale 1" = 1'-0"

See foundation note on page 2 for design information